

USER MANUAL

CONTENTS

1	BEFORE YOU BEGIN	1
1.1	WHAT IS INCLUDED.....	1
1.2	UNPACKING INSTRUCTIONS.....	1
1.3	SYMBOLS.....	1
1.4	DISCLAIMER.....	1
1.5	SAFETY NOTES.....	1
1.5.1	Personal Safety.....	1
1.5.2	Mounting and Rigging.....	2
1.5.3	Power and Wiring.....	2
1.5.4	Operation.....	2
2	INTRODUCTION	2
2.1	DESCRIPTION.....	2
2.2	FEATURES.....	3
2.3	PRODUCT OVERVIEW.....	3
2.4	PRODUCT DIMENSIONS.....	4
3	TECHNICAL SPECIFICATIONS	5
4	SETUP	5
4.1	AC POWER.....	5
4.2	AC PLUG.....	6
4.3	RESETTING THE BREAKER.....	6
4.4	DMX LINKING.....	6
4.5	MOUNTING.....	6
4.5.1	Orientation.....	6
4.5.2	Rigging.....	6
5	OPERATION	7
5.1	PREPARING FOR OPERATION.....	7
5.2	ON-DEVICE CONTROL PANEL.....	7
5.3	ON-DEVICE CONTROL MODE & OPERATION.....	7
5.3.1	Programming.....	7
5.3.2	Menu Map.....	7
5.4	DMX MODE & OPERATION.....	9
5.4.1	Starting Address.....	9
5.4.2	DMX Mode Menu Map.....	9
5.4.3	DMX Channel Assignments and Values.....	9
5.5	AUTO RUN LAST SETTINGS.....	10
5.6	FLUID SENSOR.....	10
5.6.1	Trigger "No-Fluid Protection".....	10
5.6.2	Clear "No-Fluid Protection" Warning.....	10
5.7	LOW WATER PROTECTION.....	10
6	TECHNICAL INFORMATION	11
6.1	MAINTENANCE.....	11
6.2	STORAGE.....	11
6.2.1	Machine Storage.....	11
6.3	TROUBLE SHOOTING.....	11

1 BEFORE YOU BEGIN

1.1 What Is Included



- H-SW3000 Machine
- Diversion Hose (Length 3.3m, diameter 125mm) × 2
- Power Cord
- Dual Nozzle Bracket
- Jumper Hose
- User Manual

1.2 Unpacking Instructions

Carefully unpack the product immediately and check the container to make sure all the parts are in the package and are in good condition.

If the box or the contents (the product and included accessories) appear damaged from shipping, or show signs of mishandling, notify the carrier or dealer/seller immediately. In addition, keep the box and contents for inspection.

1.3 Symbols

Symbol	Meaning
	<p>Caution</p> <p>Critical installation, configuration, or operation information. Not following these instructions may make the product not work, cause damage to the product, or cause harm to the operator.</p>
	<p>Important</p> <p>Important installation or configuration information. Failure to comply with this information may keep the product from working correctly.</p>
	<p>Information</p> <p>Useful information.</p>

1.4 Disclaimer

The information and specifications contained in this User Manual are subject to change without notice. DJPOWER assumes no responsibility or liability for any errors or omissions and reserves the right to revise or to create this manual at any time.

Copyright © 2018 DJPOWER. All rights reserved.

1.5 Safety Notes

Please read the following Safety Notes carefully before working with the product. The notes include important safety information about installation, usage, and maintenance.

1.5.1 Personal Safety

- Always connect the product to a grounded circuit to avoid the risk of electrocution.
- During heating up and operation, the housing will be scalding hot. Do not touch.
- Condensation may form on the bottom of the product, creating damp or wet conditions under and around the machine. Use caution! Surfaces around the product may become slippery.
- The product is very hot during operation and it remains hot for a long time after operation has stopped. Do not touch the product's nozzle.
- Make sure that children, unauthorised people and animals do not obtain access to the machine.
- Eye protection is always required when operate the machine closely.

1.5.2 Mounting and Rigging

- For safety reasons, we do not recommend mounting the product in any capacity. Operate the product while it is on the ground only.
- CAUTION: When transferring product from extreme temperature environments, (e.g. cold truck to warm humid ballroom) condensation may form on the internal electronics of the product. To avoid causing a failure, allow product to fully acclimate to the surrounding environment before connecting it to power.
- Do not mount the product on a flammable surface (linoleum, carpet, wood, paper, carton, plastic, etc.).
- Do not use in a confined space. Always install the product in a location with adequate ventilation, at least 20 in (50 cm) from adjacent surfaces.
- Be sure that no ventilation slots on the product's housing are blocked.

1.5.3 Power and Wiring

- Always make sure that the voltage of the outlet to which you are connecting the product is within the range stated on the decal or rear panel of the product.
- Make sure the power cord is not crimped or damaged.
- Never connect this product to a dimmer pack or rheostat.
- Never disconnect the product from power cord by pulling or tugging on the cord.
- To eliminate unnecessary wear and improve its lifespan, during periods of non-use completely disconnect the product from power via breaker or by unplugging it

1.5.4 Operation

- Do not operate this product if you see damage to the housing or cables. Have the damaged parts replaced by an authorized technician at once.
- Make sure there are no flammable materials close to this product while it is operating.
- Do not cover or plug the output nozzle during operation.
- Do not use the product as a space heater.
- Never carry the product by the power cord or any moving part. Always use the handles.
- Drain the tank before transporting the product.
- The maximum ambient temperature (Ta) is 104 °F (40 °C). Do not operate the product at higher temperatures.
- Always disconnect the product from the power source before cleaning.
- This product contains no user-serviceable parts. Any reference to servicing in this User Manual will only apply to properly trained, certified technicians. Do not open the housing or attempt any repairs which can lead to damage or malfunction.
- In the event of a serious operating problem, stop using the product immediately.
- Use only DJPOWER Consumable PRO-V/PRO-A/PRO-C



Keep this User Manual for future use. If you sell the product, be sure that the purchaser receives this document.

2 INTRODUCTION

2.1 Description

World's first monocoque frame aqua low fog machine H-SW3000, creates a continuous low-lying fog hugs the floor and dissipates without rising. By using the Ultrasonic technology, needs for dry ice is eliminated. Main consumables are pure water, environment friendly, cost saving and space saving. Enhanced material, lighter than similar models, portable and durable. User-friendly LCD display and operation, it is perfect for large clubs, large stage productions, rental companies and production release conference.

2.2 Features

- Long-lasting body design with austenite welding and anti-corrosive primer;
- Integrated in a plastic case (with castors), applicable for touring,
- Drain holes design for water tank, free from leakage;
- Advanced No-Fluid protection;
- Advanced No-Water protection;
- Anti-loose power plug;
- Low fluid consumption, 3.5L fluid reservoir -2 hours on full output;
- Built-in LCD control, 3-pin and 5-pin DMX control;
- Please use DJPOWER professional fluid PRO-V/PRO-A/PRO-C; different fluid will show different stage effect. DJPOWER PRO-V fog fluid provides an awesome Quick Dissipation effect.

2.3 Product Overview

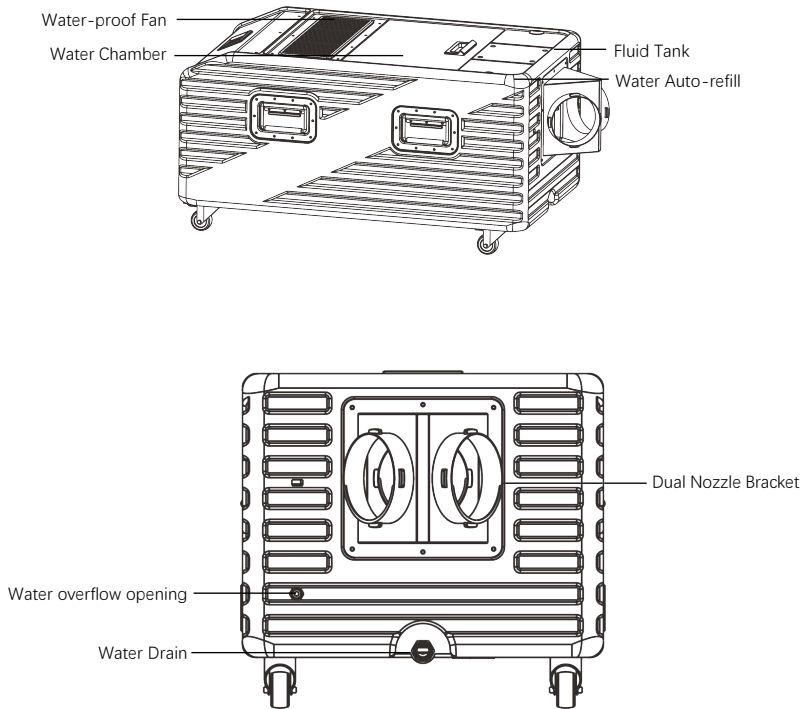

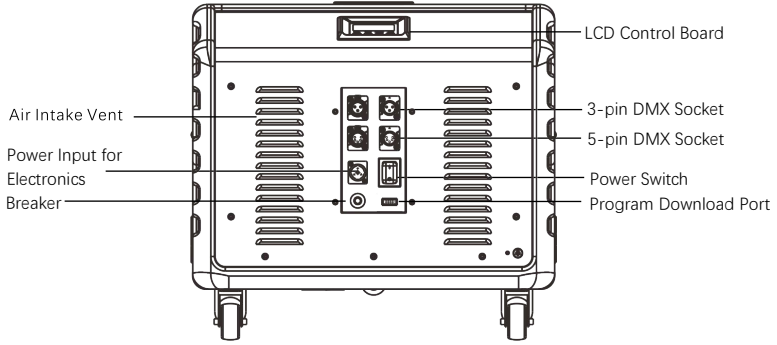

2.4 Product Dimensions

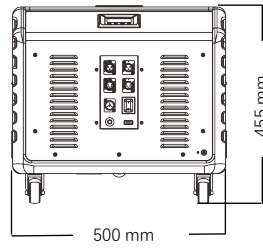
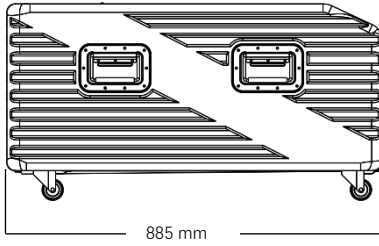

3 TECHNICAL SPECIFICATIONS

	Input Voltage & Rate	220-240 V, 50/60 Hz
AC Power	Current Limiter Type	Breaker
	Current Limiter Specifications	15 A, 250 V
	Total Power Consumption	2,700 W
	Operating Current	11.7 A
	Power Input Connector	Lockable PowerCon IP65
	Power Output Connector (Daisy Chained)	Lockable PowerCon IP65
	Heating	Heat Up Time
Total Power Consumption		1,200 W
Atomizer	Unit Quantity	4 pc
	Power Consumption of each Unit	300 W
	Adjustable	√
	Adjustment Range	0-100%
	Capacity	Fluid Tank Capacity
Water Chamber Capacity		34.0 L
Output	Adjustable Volume	√
	Volume Adjustment Level/Range	1-100%
	Max Output Volume	20,000 cuft/min
	Max Coverage	400 m ²
	Fluid Consumption @ full volume	29 min/L
	Water Consumption @ full volume	480.0 mL/min
	Continuous Output	√
	Max Continuous Output Level	100%
	Fully-loaded Cumulative Output Duration @ full volume	100.0 min
Features	Physical Thermostat	√
	Electronic Thermo-Control	√
	Adjustable Output	√
	Adjustable Fan Speed	√
	No-Fluid Protection	√
Control	On-device Manual Control	LCD control board
	Wireless Control	×
	Wired Control	×
	Control Protocol	DMX-512
	DMX Channel Range	3
Accessory	Data Connectors	3- and 5-pin XLR
	Diversion Hose	2 pc, 3 m, 125mm (5 inch)
	Diversion Nozzle	Optional 125mm (5 inch)
Consumable	Consumable	PRO-SW/PRO-A/PRO-D & Water
	Net Weight	46.0 kg
Weight & Dimensions	Gross Weight	52.5 kg
	Machine Dimensions	885 × 500 × 455 mm
	Packing Dimensions	1095 × 570 × 535 mm

4 SETUP

4.1 AC Power

The machine has a fixed voltage power supply and can work with an input voltage of AC 220 V-240 V, 50/60 Hz, depending on the specific model.

To determine the product's power requirements (circuit breaker, power outlet, and wiring), use the current value listed on the label affixed to the product's back panel, or refer to the product's specifications chart. The listed current rating indicates the product's average current draw under normal conditions.



Always connect the product to a protected circuit (circuit breaker or fuse). Make sure the product has an appropriate electrical ground to avoid the risk of electrocution or fire.



Never connect the product to a rheostat (variable resistor) or dimmer circuit, even if the rheostat or dimmer channel serves only as a 0 to 100% switch.

4.2 AC Plug

The H-SW3000 comes with a power input cord terminated with a Lockable power connector on one end. The other end is

- CN plug (CN market, etc.)
- EU plug (EU market, etc.)
- US plug (US market, etc.)

If the power input cord that came with your product has no plug, or if you need the change the plug, use the table below to wire the new plug:

Connection	Wire (U.S.)	Wire (Europe)
AC Live	Black	Brown
AC Neutral	White	Blue
AC Ground	Green/Yellow	Green/Yellow

4.3 Resetting the Breaker

This product is equipped with a resettable breaker. If the breaker trips, all sections of this product will lose power.

- Remove the power cord from mains power.
- Allow unit to cool for 15 minutes.
- After 15 minutes, you may attempt to reset the breaker by pressing the button with your finger.
- Plug the product's power cord into the power outlet and continue using as recommended.

4.4 DMX Linking

You can link the H-SW3000 to a DMX controller using a 3- or 5-pin DMX connection. If using other DMX-compatible products with this product, you can control each individually with a single DMX controller. Instructions for connecting and configuring this product for DMX operation are in the User Manual.

4.5 Mounting

Before mounting the product, read and follow the safety recommendations indicated in the Safety Notes.

4.5.1 Orientation

For safety reasons, we do not recommend mounting the product in any capacity. Operate the product while it is on the ground only, and make sure there is adequate room for ventilation, configuration, and maintenance.

4.5.2 Rigging

DJPOWER recommends using the following general guidelines when mounting this product.

- Before deciding on a location for the product, make sure there is easy access to the product for maintenance and programming purposes.
- Make sure that the structure or surface onto which you are mounting the product can support the product's weight (see the Technical Specifications).
- When mounting the product on the floor, make sure that the product and cables are away from people and vehicles.

5 OPERATION





5.1 Preparing for Operation

- After checking that all the parts are intact and complete, position the machine on flat.
- Fill the water into water tank when power off. The capacity of water tank is 34 L.
- Always connect the product to a grounded circuit. Before power on, make sure it is connected with the rated voltage.
- Turn on the machine, it will immediately start heating up.

5.2 On-device Control Panel



To access the control panel functions, use the four buttons located underneath the LCD display.



Button	Function
<MENU> 	Switch menu pages to select a function
<TIMER> 	Increases the numeric value of current function TIMER starts the timer-controlled operation
<VOLUME> 	Decreases the numeric value of current function VOLUME triggers the pump to modify the output volume
<STOP> 	Enter enables the currently displayed menu or sets the currently selected value into the selected function STOP turns the fog output off

5.3 On-device Control Mode & Operation

5.3.1 Programming

- Refer to the Menu Map to understand the menu options. The menu map shows the main level and a variable number of programming levels for each option.
- To go to the desired main level, press <MENU> repeatedly until the option shows on the display. This will take you to the first programming level for that option.
- To select an option or value within the current programming level, press <TIMER>  or <VOLUME>  until the option shows on the display. If there is another programming level, you will see that first option, or you will see the selected value.
- Press <MENU> repeatedly to switch menu pages.
- Press <STOP>  to go back to Standby Page.

5.3.2 Menu Map

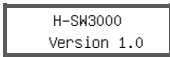
Display	Description	Parameter Range
Starting Pages		

	Display	Description	Parameter Range
	H-SW3000 AC-230V 50Hz		
Preparing Page	Heating Up >>>>>>>>>>>>>>>>>>	The machine is heating up.	
Standby Page	Ready 2 Low Fog H-SW3000	Finished heating up, ready to work.	
Working Status Pages	Interval 600s H-SW3000	Interval countdown of TIMER mode	
	Duration 300s H-SW3000	Duration countdown of TIMER mode	
	Fog Output 100% Fan Speed 100%	Output status of VOLUME mode	
Setting Pages	Fog Output 100%	Press \odot or \ominus to set fog output of VOLUME mode	1-100%
	Fan Speed 100%	Press \odot or \ominus to set fan speed of VOLUME mode	1-100%
	Humidity 100%	Press \odot or \ominus to set output humidity of VOLUME mode	OFF/25%/50%/75%/100%
	Timer Interval 600s	Press \odot or \ominus to set timer interval of TIMER mode	5-600s
	Timer Duration 300s	Press \odot or \ominus to set timer duration of TIMER mode	5-300s
	DMX Address 512	Press \odot or \ominus to select DMX starting address	1-512
	Fluid Sensor ON	Press \odot or \ominus to activate/deactivate fluid sensor to turn on/off no-fluid-protection function	ON/OFF
	Auto Run Last Settings YES	Press \odot or \ominus to set if the machine will automatically run previous setting when power on again	YES/NO
	Keypad Tone OFF	Press \odot or \ominus to turn keypad tone ON/OFF	ON/OFF
	Language(语言) English	Press \odot or \ominus to select the language and save by ENTER	Chinese/English

	Display	Description	Parameter Range
Error & Warning Pages	Water Level Low Refill Water		
	Fog Fluid Low Refill		
	Heating Failure Contact Service		

5.4 DMX Mode & Operation

The Machine H-SW3000 works with a DMX controller.

- Connect the product to a suitable power outlet.
- Turn the product on.
- Connect a DMX cable from the DMX output of the DMX controller to the DMX input socket on the product.



5.4.1 Starting Address

When selecting a starting DMX address, always consider the number of DMX channels. If you choose a starting address that is too high, you could restrict the access to some of the product's channels.





DJPOWER® H-SW3000 DMX set the starting address in the 001 - 512 DMX range and uses 3 DMX channels, which defines the highest configurable address to 510 to have all channels controllable.



Connect a DMX cable from the DMX output of the DMX controller to the DMX input socket on the product, or press repeatedly "MENU" button until the LCD shows "DMX Address". Press  or  to set desired DMX starting address.

5.4.2 DMX Mode Menu Map

When connected with DMX controller and receive DMX signal, the display will always show current DMX starting address, that can be changed anytime by pressing  or .

DMX Address 512

5.4.3 DMX Channel Assignments and Values

Channel	Function	Value	Description
1	Fog Output	000 - 010	No Function
		011 - 255	1-100%
2	Fan Speed	000 - 010	No Function
		011 - 255	1-100%
3	Humidity	000 - 010	No Function
		011 - 062	25% humidity
		063 - 122	50% humidity
		123 - 183	75% humidity
		184 - 255	100% humidity

5.5 Auto Run Last Settings

If the machine is shut off while it is operating at standalone mode (On-device & Wireless control), the "Auto Run Last Setting" will allow the machine to recover its previous same operating status when the unit is powered on again without pressing any button.



- **Shut off:** Get disconnected from power source, or turn off the power switch
- **Power on:** Get connected with power source, or turn on the power switch

5.6 Fluid Sensor

This machine uses software-based fluid sensor to detect whether there is fluid inside tube so as to protect the pump from being damaged. Turn on the "Fluid Sensor" to activate "No Fluid Protection" function.

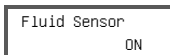

5.6.1 Trigger "No-Fluid Protection"

When the Fluid Sensor is ON, the software-based "no-fluid protection" function will be activated. After the program continues to detect the machine working with no fluid inside the tube for 90 s, the pump-shutoff will be activated with the flickering warning page showing on the screen.

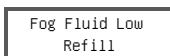

When this warning message shows up, the machine will stop work but the LCD is still operable, only keep flickering.

5.6.2 Clear "No-Fluid Protection" Warning

When the machine is under the no-fluid protection, after refilling the fluid, there are three ways to clear the warning.

- Press <STOP> (⏏) first, then press <VOLUME> (⏮) to let the machine run again, the warning will disappear until the fluid is pumped and fill the tube.
- Under the DMX control mode, bring down channel 1 to OFF (value 0-9), then back to ON (value 10-255), to let the machine run again. The warning will disappear until the fluid is pumped and fill the tube.
- Turn off "Fluid Sensor" in the menu.

The LCD will keep flickering whenever it shows the warning message or regular operation menu pages until the fluid is finally pumped into tube and sensed by software.

5.7 Low Water Protection

When the water in the chamber is low, the LCD will flicker and show the warning message as below:

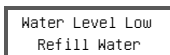

After the warning message shows up, the machine can still run for another 10 minutes with remaining water in the chamber, then shut off. Adding water in the chamber by either opening the lid on the top, or through the water auto-refill inlet.

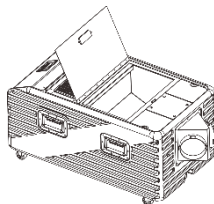

Fog output is no need to stop when open the water chamber lid, the big volume of fog will not come out towards to people from the open lid.



Water auto-refill: please use jumper hose to avoid spill.

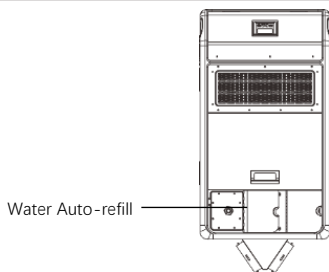

6 TECHNICAL INFORMATION

6.1 Maintenance

To avoid the H-SW3000 clogging, after every 40 hours of continuous operation, use a detergent composed of 35% vinegar and 65% distilled water through the system and fog 10-15 times after finish heating-up to prevent the accumulation of particulate matter in the heating element.

The recommended cleaning procedure is as follows.

- 1) Unplug the product from power.
- 2) Empty all fluid from the machine.
- 3) Add cleaning solution to the tank.
- 4) Connect the product to power and allow it to heat up.
- 5) Run the product in a well-ventilated area until the tank is empty. Do not allow the pump to run dry.
- 6) Refill with fog fluid to continue using the H-SW3000. Run the machine briefly to clear any cleaning solution from the pump and heater.
- 7) Excessive dust, fluid residue and dirt will degrade performance and cause overheating. Remove dust from air vents with air compressor, vacuum or soft brush. The casing could be cleaned by the damp cloth.



Test-run your DJPOWER® H-SW3000 on a monthly basis to achieve the best performance.

6.2 Storage

6.2.1 Machine Storage

Before storing the machine, clean it as described in the cleaning procedure above; however, only follow steps 1 through 5. Do not refill the tank with fog fluid if storing the machine. Cleaning the system prior to storage will help prevent any particles from condensing inside the pump or heater while not in use.

6.3 Troubleshooting

Errors	Symptom	Potential Cause	Remedies
No fluid	Refer to "MENU MAP" chapter to for more information	No fluid	Refill fluid
		Fluid pump error	Contact Service
Low water	Refer to "MENU MAP" chapter to for more information	Low water	Refill water
		Water pump error	Contact Service
Heat failure	Refer to "MENU MAP" chapter to for more information		Contact Service

